

# Xtend® Connect

## Technical Data Specification

Xtend Connect is a patented quick adapter that allows the user to disassemble his/her prosthesis in parts to make it easier to change feet, change trousers or just save space, for example when traveling. Otherwise, Xtend Connect works just like any adapter and has the most common standard interfaces to fit most prosthetic products on the market.

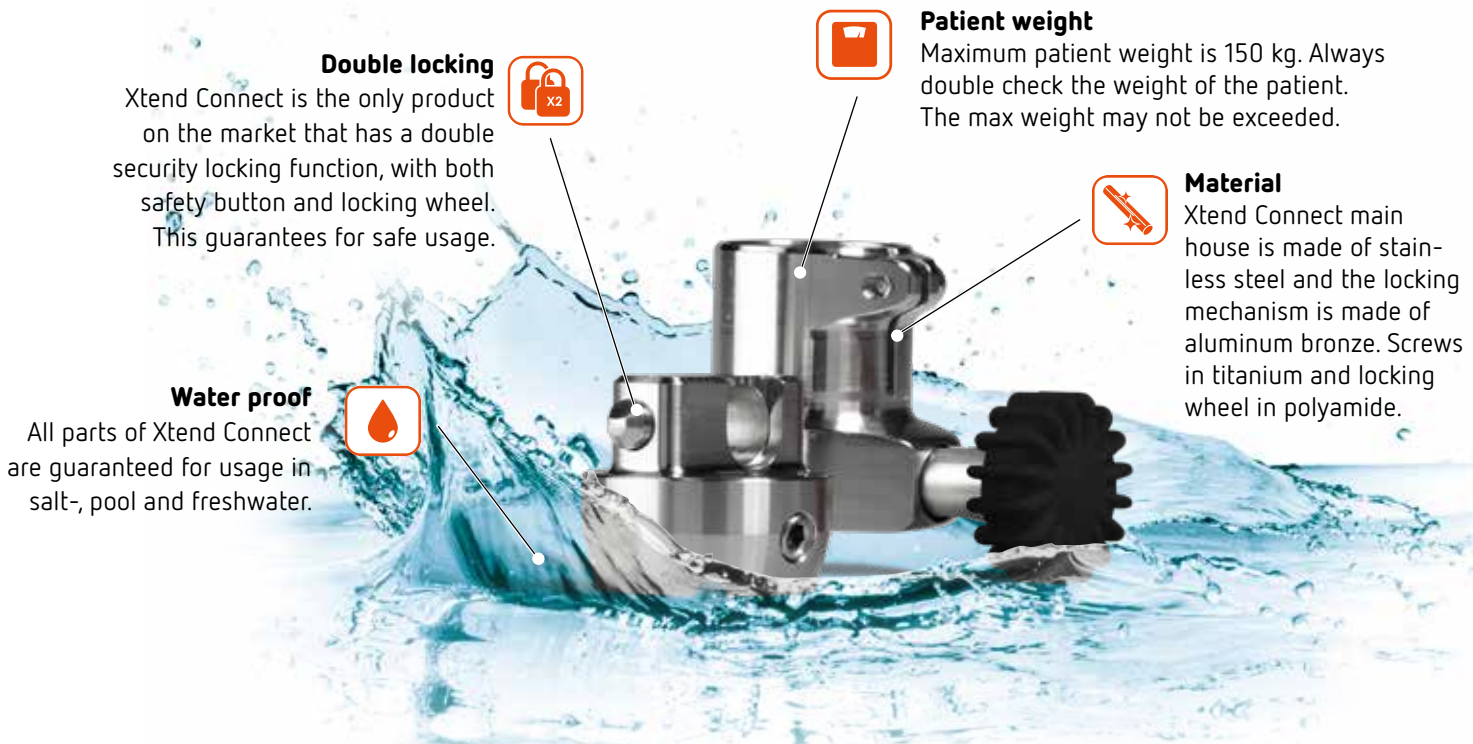

### Double locking

Xtend Connect is the only product on the market that has a double security locking function, with both safety button and locking wheel. This guarantees for safe usage.



### Patient weight

Maximum patient weight is 150 kg. Always double check the weight of the patient. The max weight may not be exceeded.



### Material





Xtend Connect main house is made of stainless steel and the locking mechanism is made of aluminum bronze. Screws in titanium and locking wheel in polyamide.

### Water proof



All parts of Xtend Connect are guaranteed for usage in salt-, pool and freshwater.



### Quick fit units

	Item number	Description
	A100-Q30-150	Xtend® Connect quick fit unit with tube clamp 30 mm, black locking wheel.
	A100-Q4-150	Xtend® Connect quick fit unit with 4-hole adapter, black locking wheel.
	A100-QF-150	Xtend® Connect quick fit unit with female pyramid adapter, black locking wheel.
	A100-QP-150	Xtend® Connect quick fit unit for prong adapter, black locking wheel.

### Base units

	Item number	Description
	A100-BF-150	Xtend® Connect base unit with female pyramid adapter.
	A100-BM-150	Xtend® Connect base unit with male pyramid adapter.

### Xtend Connect Configurator



Find out what components you need with our digital Connect Selection tool!

Not sure what components that are needed for a specific configuration? Scan the QR-code and use our online configurator.

# Technical facts Xtend® Connect

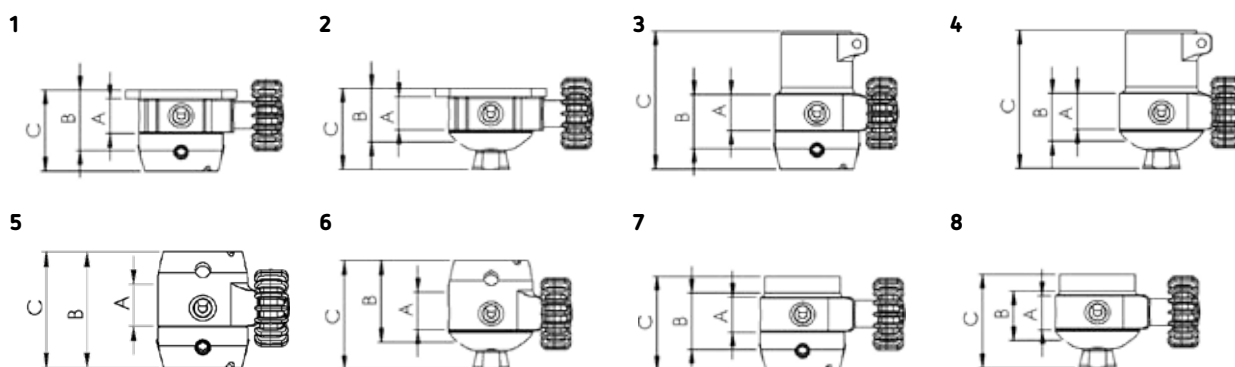

## Measurements and weight

No	Combination	Description	A	B	C	D	E
1	A100-Q4+A100 BF	Xtend Connect Quick fit unit, 4-holes adapter + Xtend Connect Base unit, female pyramid adapter	19	39	39	208	338
2	A100-Q4+A100 BM	Xtend Connect Quick fit unit, 4-holes adapter + Xtend Connect Base unit, male pyramid adapter	19	26	39	208	314
3	A100-Q30+A100 BF	Xtend Connect Quick fit unit, tube clamp 30 mm + Xtend Connect Base unit, female pyramid adapter	19	36	66	208	330
4	A100-Q30+A100 BM	Xtend Connect Quick fit unit, tube clamp 30 mm + Xtend Connect Base unit, male pyramid adapter	19	23	66	208	305
5	A100-QF+A100 BF	Xtend Connect Quick fit unit, female pyramid adapter + Xtend Connect Base unit, female pyramid adapter	19	52	52	208	303
6	A100-QF+A100 BM	Xtend Connect Quick fit unit, female pyramid adapter + Xtend Connect Base unit, male pyramid adapter	19	39	52	208	279
7	A100-QP+A100 BF	Xtend Connect Quick fit unit, M36 adapter + Xtend Connect Base unit, female pyramid adapter	19	37	44	208	299
8	A100-QP+A100 BM	Xtend Connect Quick fit unit, M36 adapter + Xtend Connect Base unit, male pyramid adapter	19	24	44	208	274

**A** Functional height in mm **B** Effective height in mm **C** Total height in mm **D** Effective weight in g **E** Total weight in g

## How to order

The Xtend Connect is delivered with black locking wheel as a standard. For orange locking wheel add -O as a suffix. For intensive sports users the maximum weight is 100 kg.